



## Spare Parts Catalogue danfoil AirBoss

### Options

**danfoil**®  
- less is more...



**Hovednummer:**  
+45 98 67 42 33

**Vagttелефон: (april til oktober):**  
+45 40 43 12 33

**Fax:**  
+45 98 67 34 88

**E-mail:**  
[info@danfoil.dk](mailto:info@danfoil.dk)

**Adresse:**  
danfoil a/s  
Jellingvej 14  
DK-9230 Svenstrup  
[www.danfoil.dk](http://www.danfoil.dk)

**Servicepartner**  
**TBS Maskinpower A/S**  
Ørderup Kirkevej 43  
6520 Toftlund  
Tlf. 75 38 11 22  
[www.tbs.dk](http://www.tbs.dk)

**Snertinge Maskinforretning A/S**  
Skelbæk 12  
4460 Snertinge  
Tlf. 59 26 80 04  
[www.s-mf.com](http://www.s-mf.com)

Se [www.danfoil.dk](http://www.danfoil.dk) for komplet  
forhandlerliste for Danmark.

**Norge**  
**AGRITEKNIKK AS**  
V/ Geir Arne Skyrud  
Østgården  
NO-2265 Namnå  
Tlf. +47 46842610  
[geir@agriteknikk.no](mailto:geir@agriteknikk.no)

**Sverige**  
**Håkan Svegrup**  
Reservelede/Service/Test  
Vindbackgården  
SE-241 92 Eslöv  
Tlf. +46 (0)708924116  
[hs@danfoil.dk](mailto:hs@danfoil.dk)

**Finland**  
**Suomen Yrittäjien Maatalous OY**  
Alhoniituntie 4  
FIN-01900 Nurmijärvi  
Tlf. +358 92764 550  
Fax. +358 92764 5555

**Tyskland/Schweiz**

**Land und Baumaschinen Service AG**  
Brühlstrasse 7  
CH-4107 Ettingen  
Tlf. +41 61722 0655  
Fax. +41 61722 0658  
[info@lubs.ch](mailto:info@lubs.ch)

Kontakt danfoil på  
+45 98 67 42 33 eller  
[info@danfoil.dk](mailto:info@danfoil.dk)

**Estland**  
**Starfeld OÜ**  
Aretuse 7  
Märje Täthvere Vald  
EE-61406 Tartumaa  
Tlf. +372 (0)7346855  
[www.starfeld.ee](http://www.starfeld.ee)

**Litauen**  
**Technikos tiekimo kompanija UAB**  
Azuolytes g. 2  
LT-37176 Panevezys  
Tlf. +370 61451213  
[www.ttk.lt](http://www.ttk.lt)

**Øvrige Europa**  
Kontakt danfoil på  
+45 98 67 42 33 eller  
[info@danfoil.dk](mailto:info@danfoil.dk)

#### DK

Ret til ændringer i priser og specifikationer uden varsel forbeholdes. Ligeledes tages forbehold for trykfejl.  
I øvrigt gælder almindelige salgs- og leveringsbetingelser for danfoil a/s.  
Eftermontering af udstyr pålægges monteringsomkostninger.  
Der tillægges et gebyr på 150,- kr. på ordre under netto 500,- kr.  
Denne prisliste annullerer alle tidligere prislister og er gyldig fra 01.09.2013.  
Priser i DKK, ab fabrik (Incoterms 2010), Excl. Moms

#### ENG

The company reserves the right to alter its prices and any specifications at any time.  
The prices are based on present exchange rate.  
Conditions of Sale are "General Conditions for Sales and Delivery for danfoil a/s.  
Mounting of extra equipment after delivery will be charged  
For orders below DKK 500,- a fee for DKK 150,- will be added  
All previous lists cancelled. This price list is effective from 1<sup>st</sup> of September 2013.  
Prices EXW (Incoterms 2010), exclude VAT and taxes.

Psc	Pos	Psc	Number	Name	Price	Note
			Forside AB 20	Forside AB 2013 Options		1
			60604660	GPS modem kit incl. antenne		2
			60602016	Arbejdslys Hella LED - Til 2-delt bom		3
			60602018	Arbejdslys Hella LED - Til 3-delt bom		4
			60600006	Endedyser sæt for kpl. bom		5
			90510396	LS-forstærker flow komplet kit		6
			90510395	LS-forstærker tryk komplet kit		7
			60602030	Elektronisk vindmåler		8
			20602060	Fyldeflowmåler automatisk EAB		9
			60602045	Selvnivellerende bom EAB		10
			20200080	Højtryksrensere med slangerulle AB		11
			60604537	115 AR Pumpe t/omrøring kpl. EAB		12
			60604538	Combi-udstyr f/Basis injec. EAB		13
			20200120	Trinbræt AB		14
			60602020	Kemikalieskab		15
			60601060	Elektronisk styring af omrørerpumpe		16
			20203020	Flydende gødnings linje		17
			90330308	Båndsurringsæt 3 m- 25mm sort		18
			90330309	Ekstra platform til AB (venstre side)		19
			60603005	Flydende gødning fra 150-300L/ha		20
			60603000	Flydende gødning op t. 150L/ha		21
			HYD_XJS	Højtryksrensere		22



Pos	Psc	Number	Name	Price	Note
1	1	90404660	GPS modem kit incl. antenne		

Side 2



Pos	Psc	Number	Name	Price	Note
1	1	90400176	Lygte Hella Power Beam 1500		
	10	90400037	Kabel 2x0.75 sort kappe		
2	1	90407513	2-pole connector female		
	1	90407514	for 2-pole female holder		
	2	90407524	female type		
	1	90320352	Slangeholder 20 mm enkelt grøn		





Pos	Psc	Number	Name	Price	Note
1	1	90400176	Lygte Hella Power Beam 1500		
	10	90400037	Kabel 2x0.75 sort kappe		
2	1	90407513	2-pole connector female		
	1	90407514	for 2-pole female holder		
	2	90407524	female type		

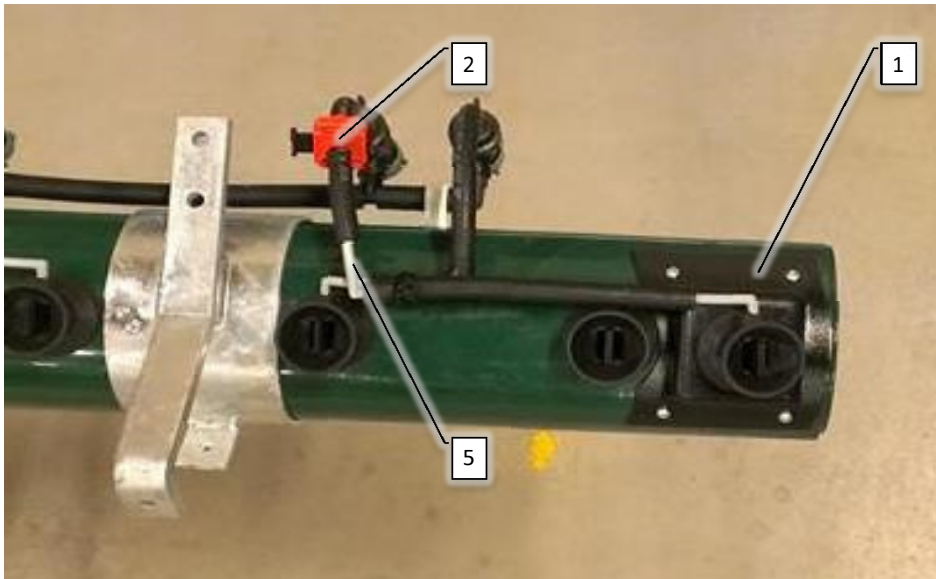
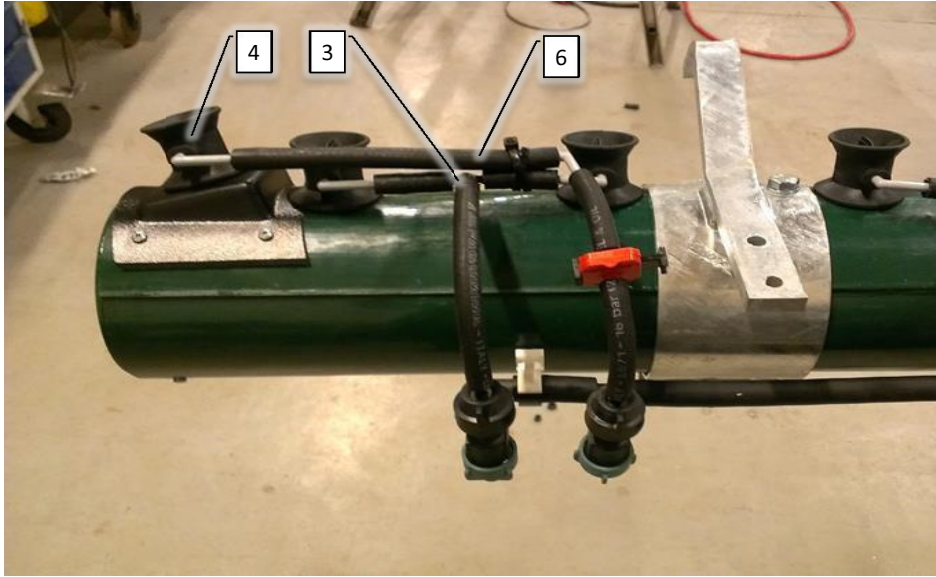

Pos	Psc	Number	Name	Price	Note
1	1	90320109	Endedyse, skærm		
2	1	90320099	Plasson minihane		
3	1	90326060	Drypstop 2011-> grøn db.		
4	1	90320083	Eurofoil forstøver kompl.		
5	1	90326015	Fordeler 2011-2014 grå/grå enk.		
6	0,25	90340001	Slange 6,3mm - tryk		

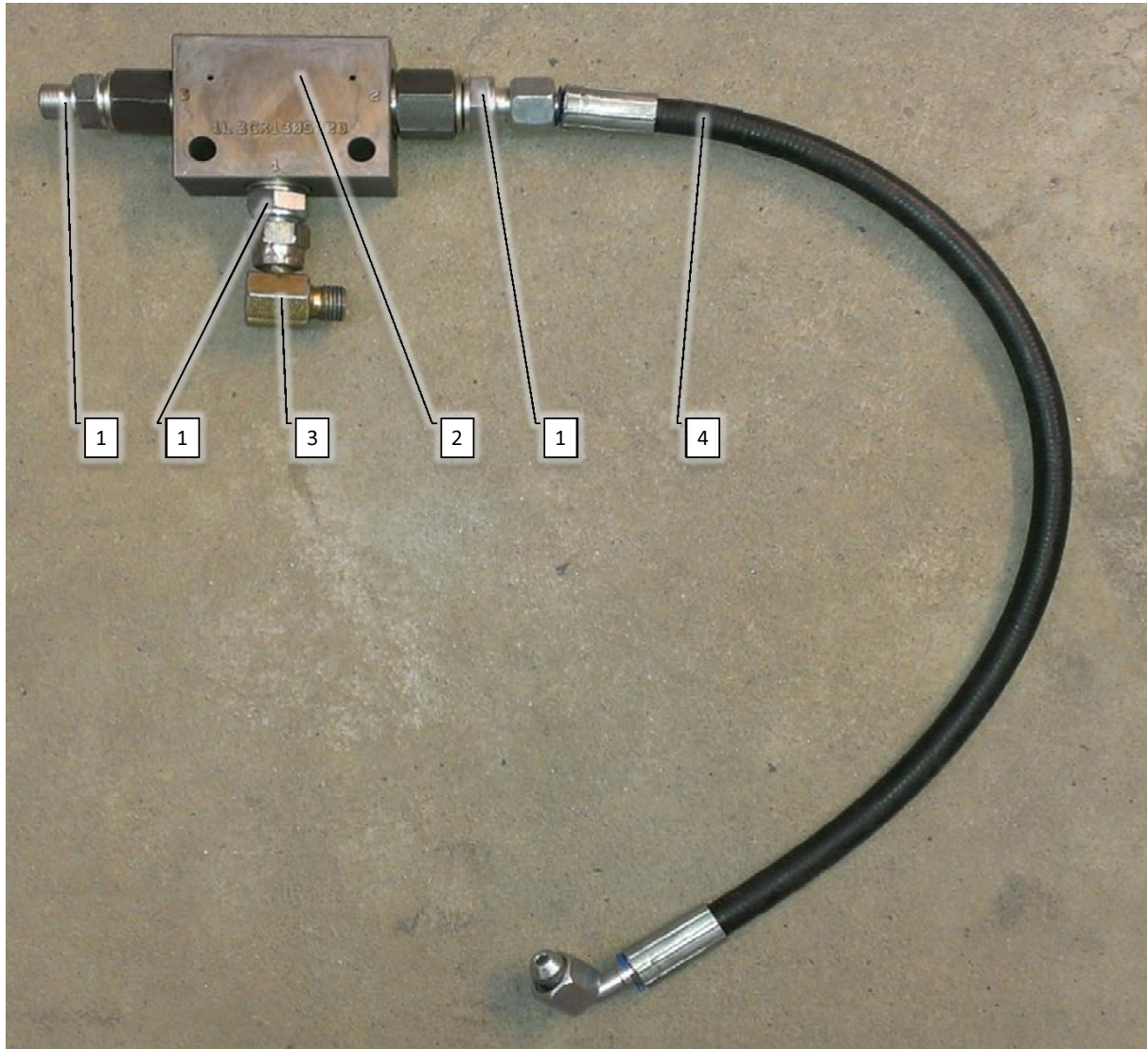

Pos	Psc	Number	Name	Price	Note
1	1	90510040	Hy brystnippel 1/4' x 1/4' BSP Male		
		90510055	Bonded seals hydr.1/4'		
2	1	90510212	LS forstærker Flow (158 H 805500)		
3	1	90510268	Hy nippel 1/4 m omløber		
		90510055	Bonded seals hydr.1/4'		
4	1	90510187	Hy slangekob 1/4 BSP F 1/4		
		90510280	Hylse 1/4 MF2000		
	0,6	90510246	Hy slange 1/4 løbende meter 1-lags		
	1	90510196	Hy slangekob 1/4 BSP F 90 1/4		

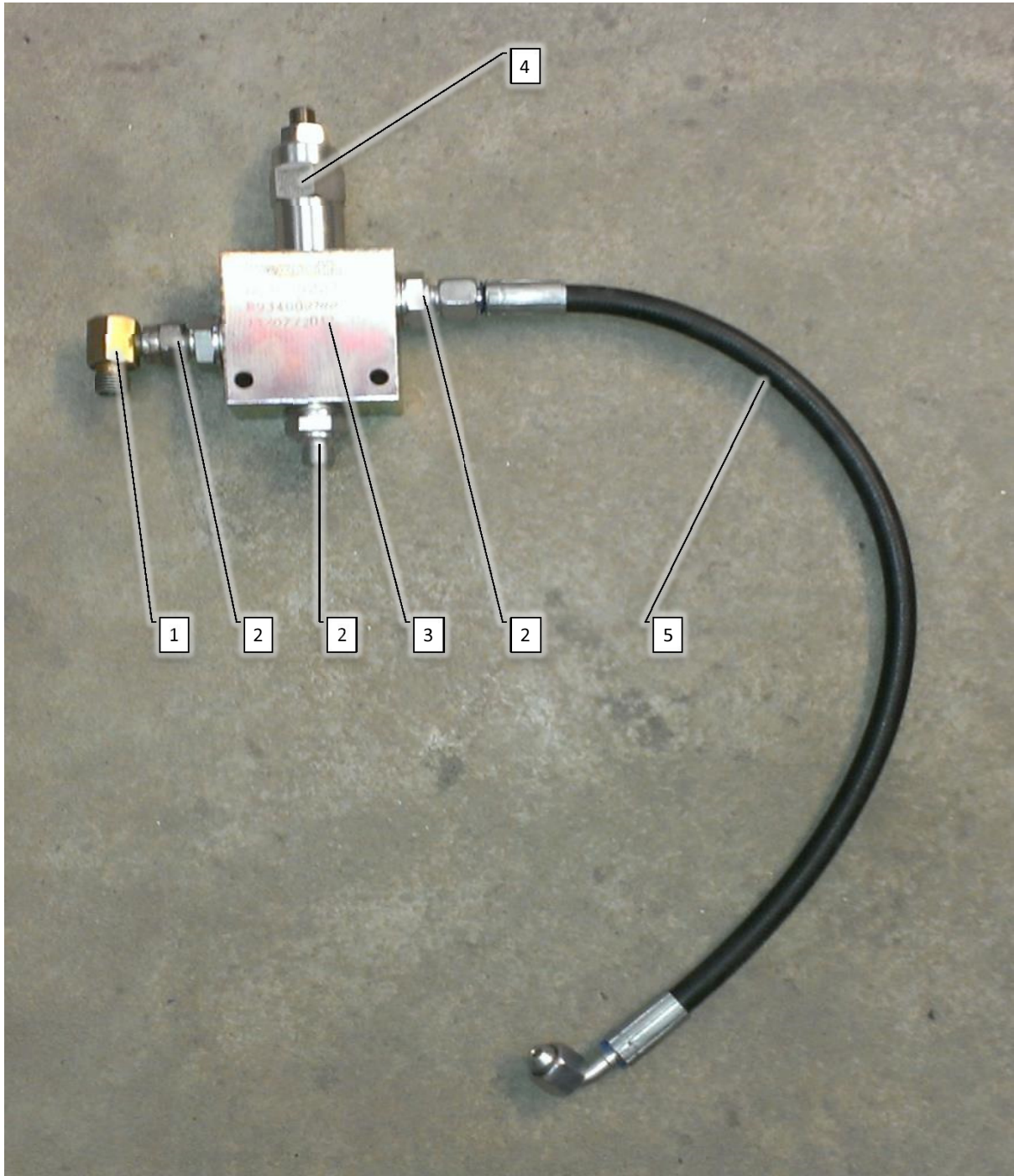

Pos	Psc	Number	Name	Price	Note
1	1	90510268	Hy nippel 1/4 m omløber		
	1	90510055	Bonded seals hydr.1/4'		
2	1	90510041	Hy brystnippel 1/4' x 3/8'		
	1	90510056	Bonded seal hydr. 3/8'		
3	1	90510072	Hy hus for LS forstærker tryk		
4	1	90510327	Patron t/LS forstærker tryk		
5	1	90510187	Hy slangekob 1/4 BSP F 1/4		
	2	90510280	Hylse 1/4 MF2000		
	0,6	90510246	Hy slange 1/4 løbende meter 1-lags		
	1	90510196	Hy slangekob 1/4 BSP F 90 1/4		





Pos	Psc	Number	Name	Price	Note
1	1	90400017	Vindmåler		
	1	90330463	Beslag f. elektronisk vindmåler		



Pos	Psc	Number	Name	Price	Note
1	1	90320501	Slangest. G1 1/4'x25mm ARAG		
		90320513	Omløber G1 1/4' ARAG		
	2	90325026	O-ring G1 1/4' Arag		
2	1	90320452	UDG: Spidsmuffe G1 1/2'xG1 1/4'		
3	1	90400016	Flowmåler Ø26 10m fyldeflowmål		
		90400013	Gevindstuds Ø 26x1 500udv g		
4	1	90400026	Motorventil t.fyldeflowmåler		
		90334801	Konsol fylde flowmåler 95mm bred		
		90400162	Kabel f. motorventil 1,5m		
5	1	90320453	Nippelreduktion G1 1/2'xG1 1/4' ARAG		

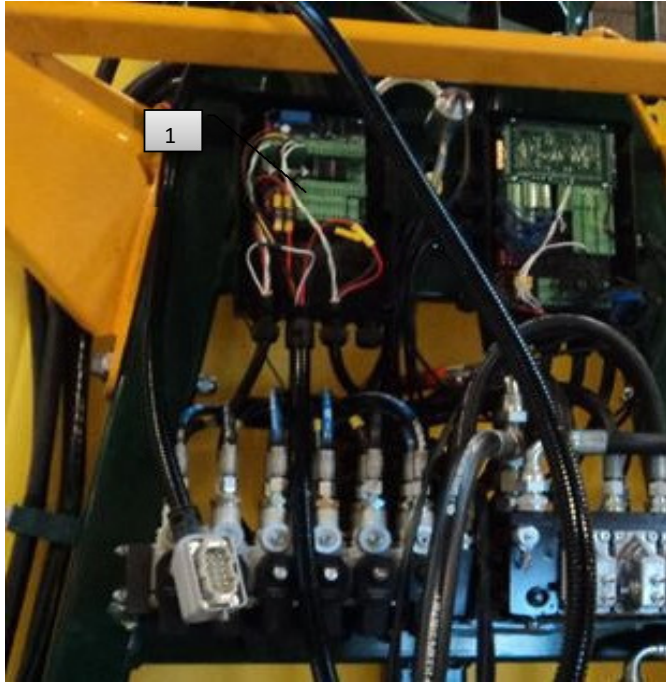

Pos	Psc	Number	Name	Price	Note
1	1	90404602	Mini jobcomputer f/Spray Controller V1		
	3	90327240	Ledning f. ultraudgiv sensor 20-28m		
	3	90330249	Beslag f. føler højderegulering		
	3	90404515	Ultralydsgiver f bomregulering		

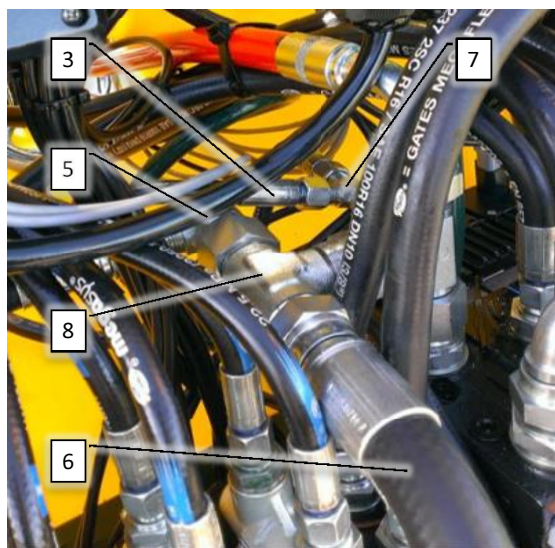
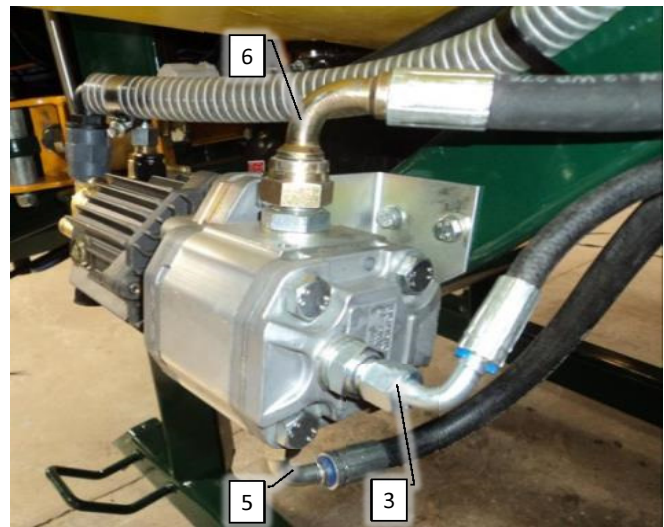
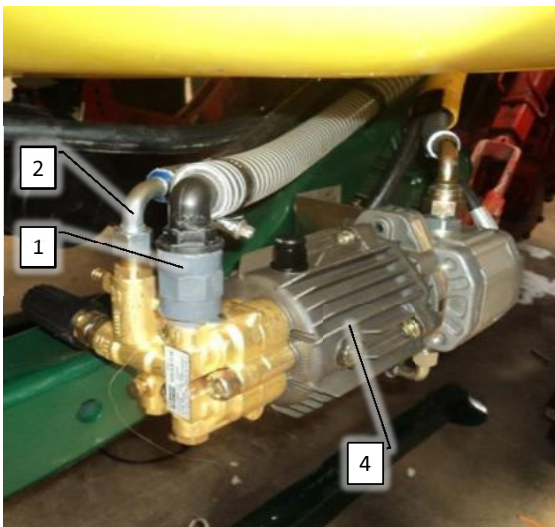

Pos	Psc	Number	Name	Price	Note
1	1	90320258	Muffe G1/2' ARAG		
	1	90320290	Slangeforsk. 1/2"x20x90°		
	1	90210088	Spændebånd 12-22/9 C7 W3		
1,8	90340049	Slange 20mm Alfasteel m. stålspiral			
	1	90210088	Spændebånd 12-22/9 C7 W3		
	1	90320434	Slangest. G1'x20mm 90G ARAG		
	2	90325061	Brystnippel G1' ARAG		
	1	90320255	T-stykke G1' F-F-F ARAG		
2	1	90510481	Hy slange 3/8" 1250mm (Lige-90)		
	1	90510042	Hy brystnippel 3/8' BSP Male		
	1	90510056	Bonded seal hydr. 3/8'		
3	1	90510041	Hy brystnippel 1/4' x 3/8'		
	1	90510056	Bonded seal hydr. 3/8'		
	1	90510480	Hy slange 1/4" 1550mm (Lige- 90)		
4	1	90320171	Pumpe/motor højtryksrenser		
5	1	90510043	Hy brystnippel 3/8'x1/2'		
	1	90510057	Bonded seal hydr.1/2'		
	1	90510482	Hy slange 3/8" 2000mm (Lige-90)		
	1	90510043	Hy brystnippel 3/8'x1/2'		
	1	90510057	Bonded seal hydr.1/2'		
6	1	90510483	Hy slange 1/2" 1500mm (Lige-90)		
	1	90510035	Hy brystnippel 1/2' x 1/2'		
	1	90510057	Bonded seal hydr.1/2'		
7	1	90510170	Hy Tee 1/4 MA/MA/FMA		
8	1	90510213	Hy T 3/4 M/ FM / M		
15	1	90325077	Beskyttelsehætte t/lance HT-renser		
	1	90320075	Muffe 1/4 t/højtryksrenser		
	1	90520048	Dyse t. højtryksrenser		
16	1	90325072	Lance f. pistolgreb højtryksrenser		
17	1	90325057	Pistolgreb højtryksrenser		
18	1	90510248	Nippelmuffe t. håndtag højtryksrenser		
19	1	90320084	Slangeholder 12 mm, enkelt		
20	1	90320170	Slangerulle for højtryksrenser 15 m		
	1	90330560	Mont.beslag højtryksrenser AB		
	4	90210011	Bolt M8x20 FZB 8.8 ubrust		
A		HYD_XJS			

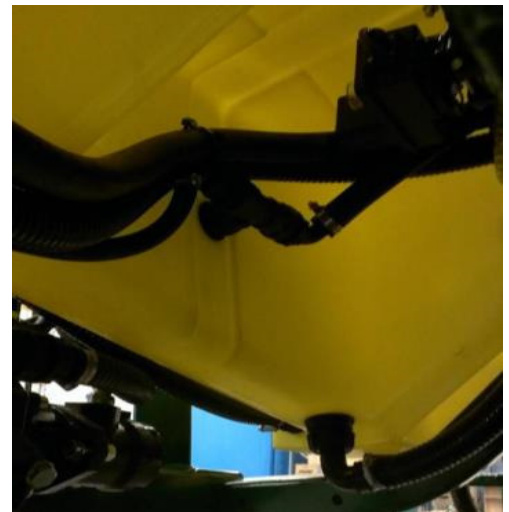



Pos	Psc	Number	Name	Price	Not Note
A	1	20200005	Væskepumpesystem Std. AB		
1	1	90510420	Flange f/SAE-QA m/ø25 f/AR115 Pumpe 25		

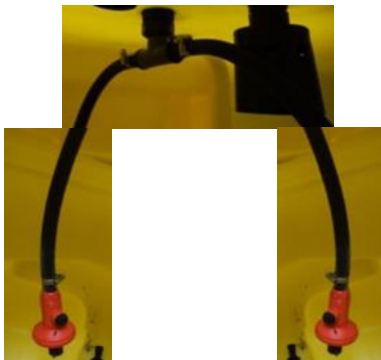

Pos	Psc	Number	Name	Price	Not Note
A	1	20200003	Betjeningspanel Std. AB		
B	1	20200004	Kemifylder klargjort AB		
C	1	20200015	Tank 1000L AB Ekstra til Std.		

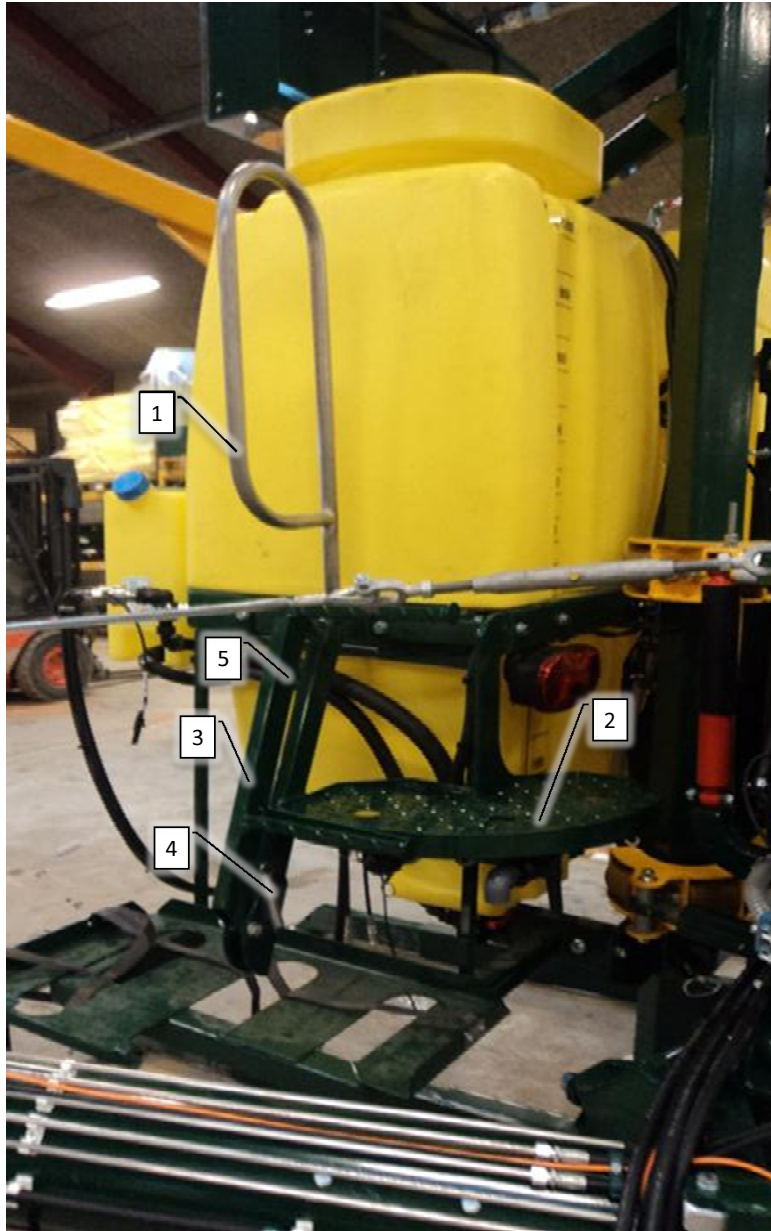

Pos	Psc	Number	Name	Price	Note
1	1	90330449	Gelænder for AB		
		1 90210241	Bolt M6x30 A2 buttonhead		
		1 90210053	Møtrik M6 FZB låse		
2	1	90330450	Trinbræt for AB		
	3	90210049	Bolt M12x25 FZB 8.8 ubryst		
	3	90214408	Skive M12 FZB Facet		
3	1	90330451	Stige for AB		
	1	90210041	Bolt M12x45 FZB 8.8 ubryst		
	2	90214408	Skive M12 FZB Facet		
	1	90210056	Møtrik M12 FZB låse		
4	1	90310070	Fjeder t. trinbræt AB		
5	1	90400143	Vibrationsdæmper f trinbræt		
	1	90900073	Mærkat - Påfyldning		



Pos	Psc	Number	Name	Price	Note
1	1	1 90105010	Mont.sæt f/traktor PC styring std.		
		1 90320513	Omløber G1 1/4' ARAG		
2	1	1 90320264	Spidsmuffe G1 1/2'xG1 1/4' ARAG		
3	1	1 90334801	Konsol fylde flowmåler 95mm bred		
		1 90400013	Gevindstuds Ø 26x1 500udv g		
		1 90400016	Flowmåler Ø26 10m fyldeflowmål		
4	1	1 90400026	Motorventil t.fyldeflowmåler		
		1 90400161	Kabel f motorventil 6m		
1	1	1 90320453	Nippelreduktion G1 1/2'xG1 1/4' ARAG		
		2 90320513	Omløber G1 1/4' ARAG		
		1 90320531	Slangest. G1 1/4'x32mm 90G ARAG		





Pos	Psc	Number	Name	Price	Not Note
1	1	90400086	Trykknop Start		
	5	90400037	Kabel 2x0.75 sort kappe		
2	1	20200204	PVG modul 4		

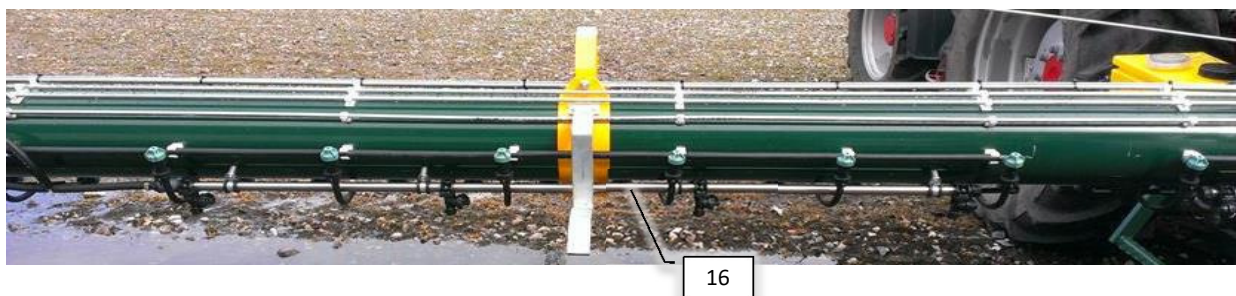
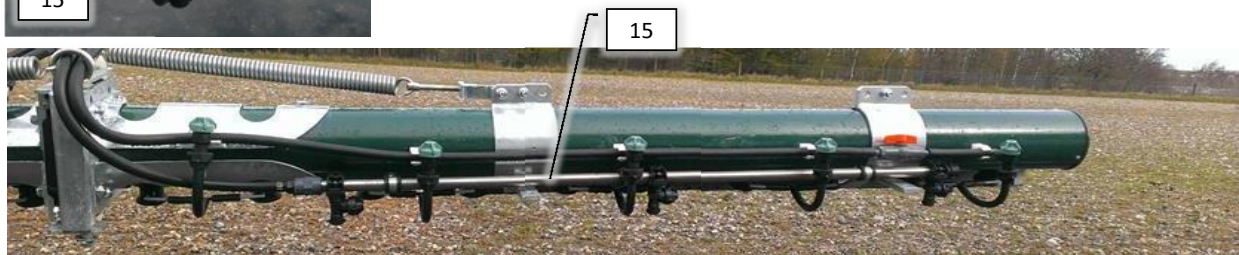
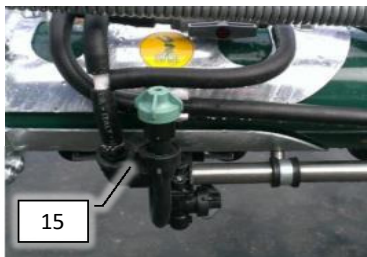
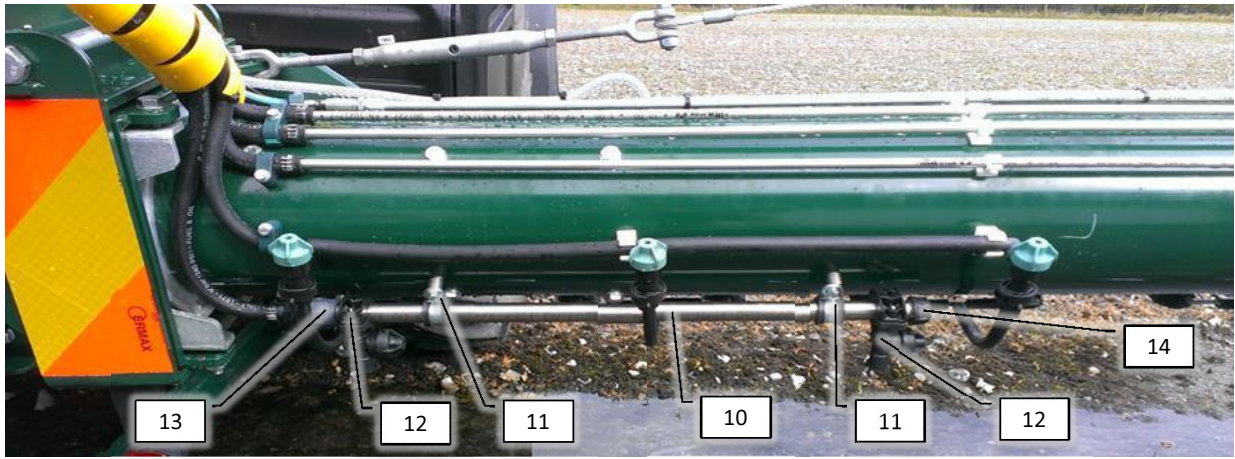
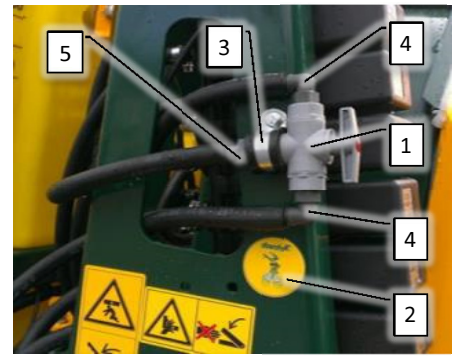
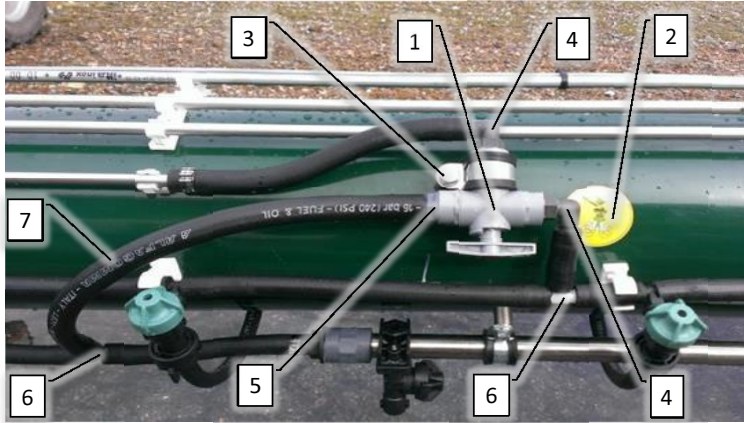

Pos	Psc	Number	Name	Price	Not Note
1	1	90320273	Kuglehane 3/8' 3-vejs		
2	1	90900065	Mærkat - filter/foil AB/CC		
3	1	90215017	Clamps 25 mm. 25/20		
	1	90330288	Bøsning Ø14x2x20 A2		
	1	90210006	Bolt M6x50 FZB 8.8 ubrust		
	1	90214405	Skive M6 FZB Facet		
	1	90210106	Jacknut 11.2 M6-LN		
4	2	90320199	Slangeforsk.3/8"x10x90°Norma		
5	1	90320286	Slangeforsk.3/8"x10mm		
6	1	90320243	T-slangestuds 10-10-10mm/TS 10		
7	1	90340019	Slange 10 mm - tryk		
10	1	90327536	Gødningsrør 57x2 stål		
11	2	90215013	Clamps 20 mm 20/20		
	2	90330288	Bøsning Ø14x2x20 A2		
	2	90210020	Bolt M6x40 FZB 8.8 ubrust		
	2	90214405	Skive M6 FZB Facet		
	2	90210106	Jacknut 11.2 M6-LN		
12	2	90327541	Gødningsholder t. dyser		
13	1	90320258	Muffe G1/2' ARAG		
	1	90320652	Slangeforsk. G1/2'x10mm ARAG		
	1	90210237	Slangeklemme Cobra 17/8 W4		
14	1	90320081	Låg G1/2'		
10	1	90327537	Gødningsrør 107x3 stål		
11	3	90215013	Clamps 20 mm 20/20		
	3	90330288	Bøsning Ø14x2x20 A2		
	3	90210020	Bolt M6x40 FZB 8.8 ubrust		
	3	90214405	Skive M6 FZB Facet		
	3	90210106	Jacknut 11.2 M6-LN		
12	3	90327541	Gødningsholder t. dyser		
13	1	90320258	Muffe G1/2' ARAG		
	1	90320652	Slangeforsk. G1/2'x10mm ARAG		
	1	90210237	Slangeklemme Cobra 17/8 W4		
14	1	90320081	Låg G1/2'		
16	1	90327538	Gødningsrør 157x4 stål		
11	4	90215013	Clamps 20 mm 20/20		
	4	90330288	Bøsning Ø14x2x20 A2		
	4	90210020	Bolt M6x40 FZB 8.8 ubrust		
	4	90214405	Skive M6 FZB Facet		
	4	90210106	Jacknut 11.2 M6-LN		
12	4	90327541	Gødningsholder t. dyser		
13	1	90320258	Muffe G1/2' ARAG		
	1	90320652	Slangeforsk. G1/2'x10mm ARAG		
	1	90210237	Slangeklemme Cobra 17/8 W4		
14	1	90320081	Låg G1/2'		
15	1	90320146	Vinkel G1/2' 90G F-F ARAG		
	1	90320652	Slangeforsk. G1/2'x10mm ARAG		
	1	90210237	Slangeklemme Cobra 17/8 W4		
	1	90320081	Låg G1/2'		

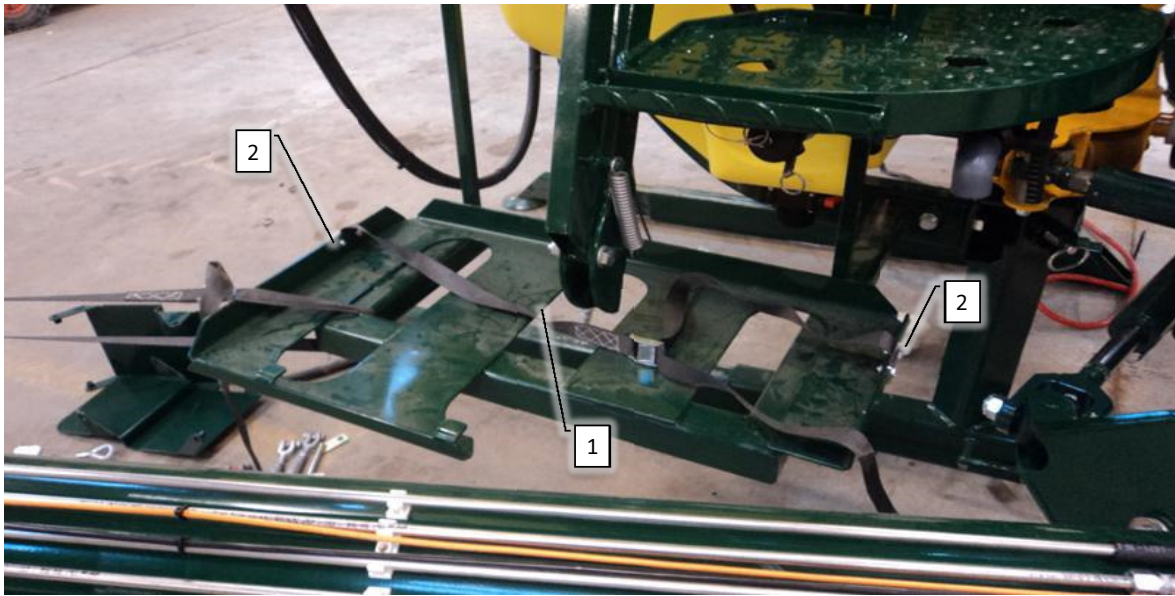

Pos	Psc	Number	Name	Price	Note
1	1	90214106	Båndsurring 5 m- 25mm sort 500kg		
2	1	90330399	Laskeplade lille CC		
	2	90210002	Bolt M6x20 FZB 8.8 ubryst		
	4	90214405	Skive M6 FZB Facet		
	2	90210053	Møtrik M6 FZB låse		



Pos	Psc	Number	Name	Price	Note
1	1	90330311	Platform f. kemikaliedunke V AB		
2	1	90210265	Bolt M16x110 FZB 8.8 bryst		
	2	90210076	Skive M16 FZB Facet		
	1	90210070	Møtrik M16 FZB låse		
3	2	90210049	Bolt M12x25 FZB 8.8 ubryst		
	2	90214408	Skive M12 FZB Facet		
A	1	90330308	Båndsurringsæt 3 m- 25mm sort		
B	1	60604114	UDG: Tilkoblingsstuds til renses20200150		
C	-1	60604115	Tilkoblingsstuds expander til rensesyste		





Pos	Psc	Number	Name	Price	Not Note
A	1	20203020	Flydende gødnings linje		



Pos	Psc	Number	Name	Price	Not Note
A	1	20203020	Flydende gødnings linje		

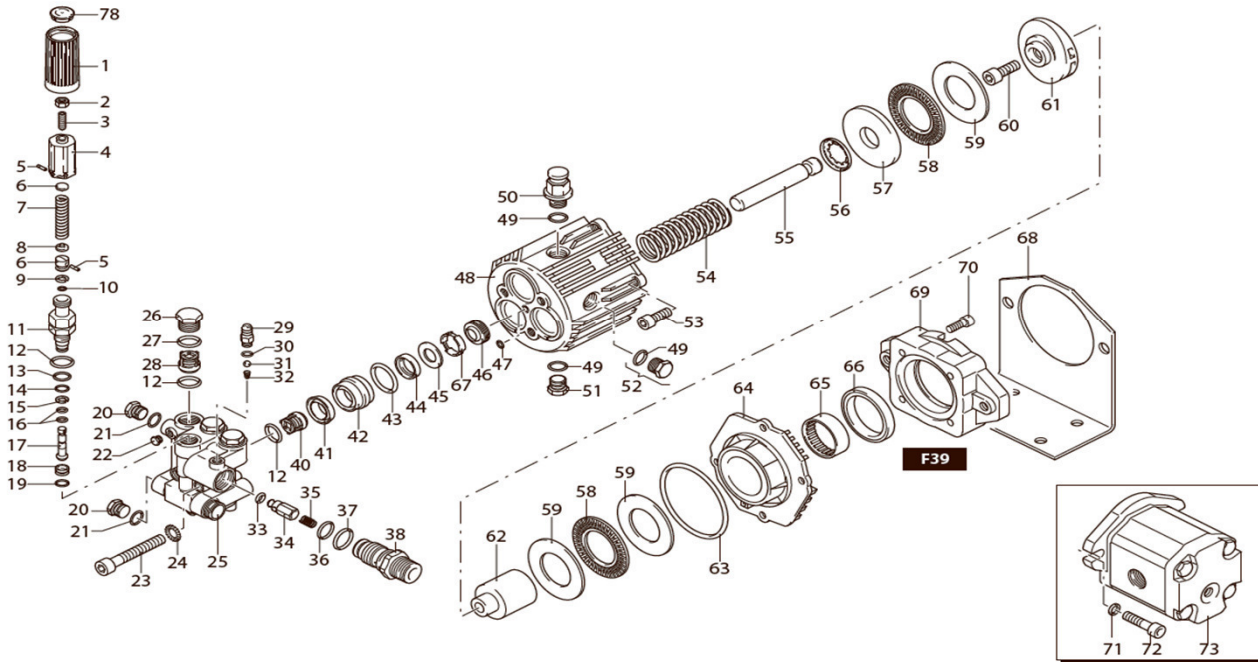

## KIT RICAMBI / PART KITS

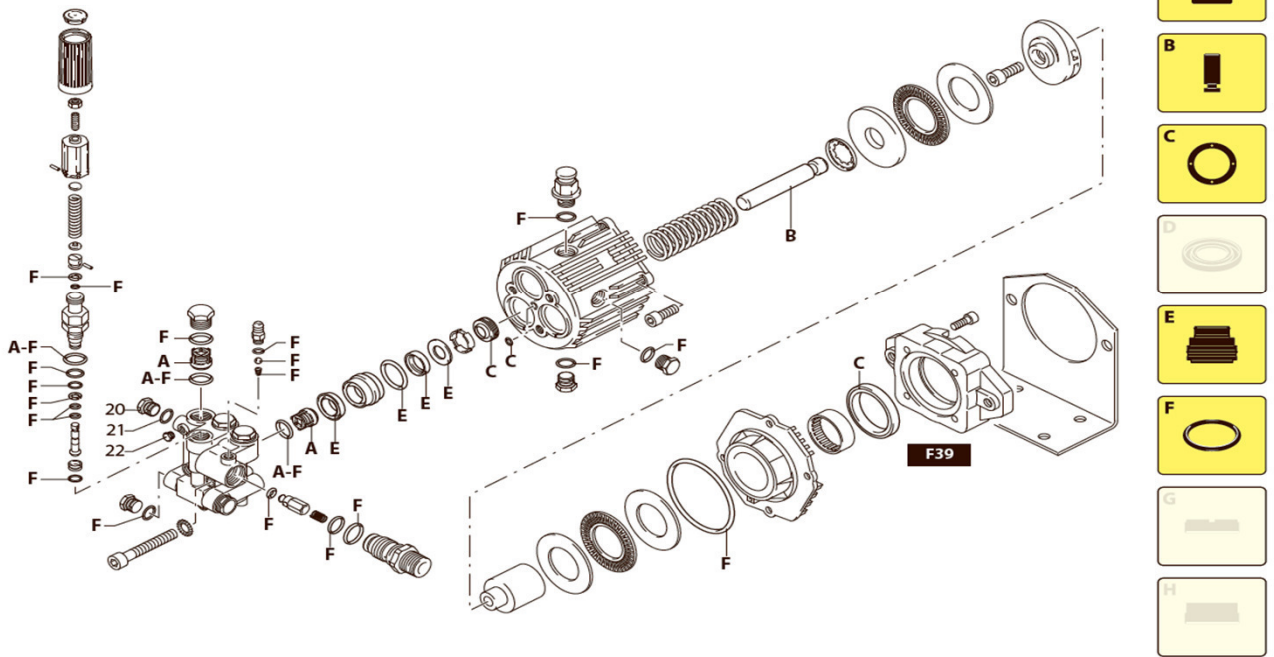

Pos	Psc	Number	Name	Price	Note
Top		90320171	Pumpe/motor højtryksrenser		
73		90320586	Hyd.motor t/højtryksrenser		
NA		90320585	Væskepumpe til højtryksrenser		
A		90327461	Ventilsæt f/højtryksrenser		
C		90327460	Olie Pak. sæt for højtryksrenser		
E		90320174	Væske Pak. sæt f. højtryksrenserpumpe		
NA		90320075	Muffe 1/4 t/højtrykrener		
NA		90320170	Slangerulle for højtryksrenser 15 m		
NA		90325057	Pistolgreb højtryksrenser		
NA		90325072	Lance f. pistolgreb højtryksrenser		
NA		90330560	Mont.beslag højtryksrenser AB		
NA		90520048	Dyse t. højtryksrenser		

***danfoil***®

Jellingvej 14 | DK-9230 Svenstrup J

Tlf. +45 98 67 42 33

[www.danfoil.dk](http://www.danfoil.dk) | [info@danfoil.dk](mailto:info@danfoil.dk)

