

AB: 20200017

Section Valve (7 or 8)

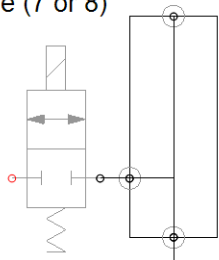

AB: 20200004

Injection can flushing

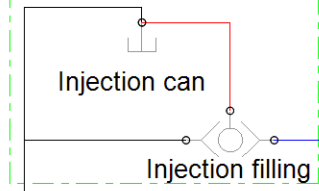

AB: 20200011

AB: 20200015

Main Tank Cleaning

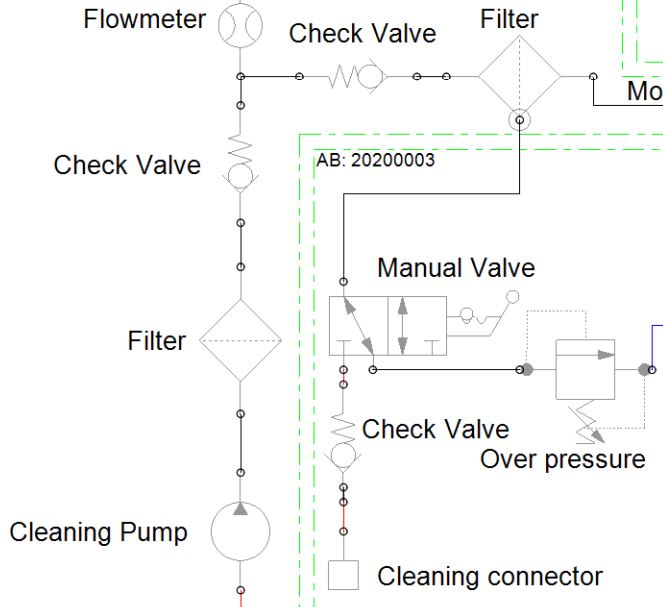

AB: 20200003

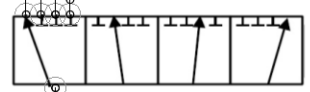

Main Tank Stirring

AB: 20200005

Main Pump

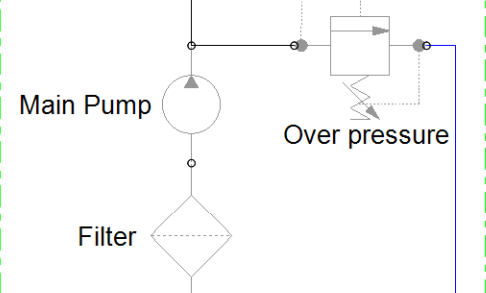

Over pressure

Filter

AB: 20200003

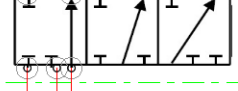

AB: 20200031

External

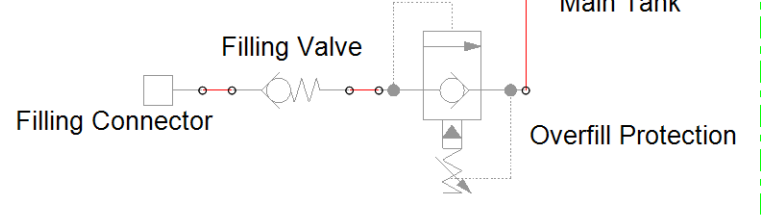

Main Tank

Filling Valve

Filling Connector

Overfill Protection

Clean Water Tank

AB: 20200017

Manual Valve

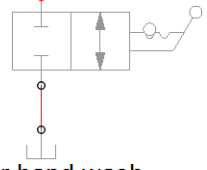

Tank for hand wash

Red = Suction line
 Blue = Retim line
 Black = Pressure line
 Green = Bom Item nr.

The information contained in this document is property of danfoil A/S, and its use and distribution are restricted

danfoil A/S

Standard water flow diagram
AB CC AC

91000020

Rev: 1
 By: Martin Søren
 Date: 1/2/2013